

L = 205

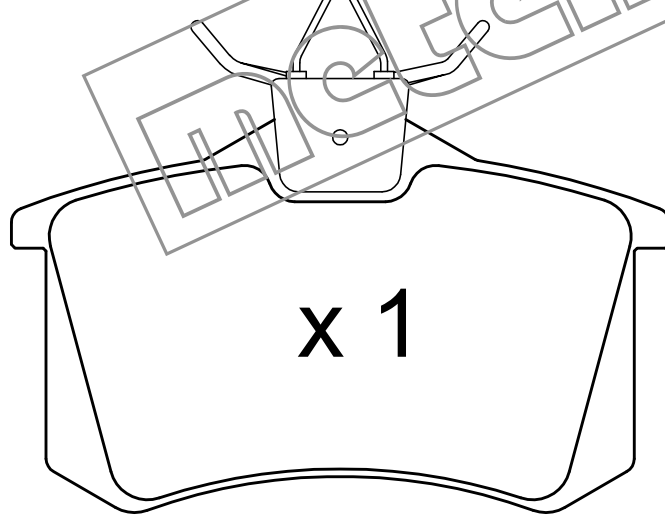

x 1

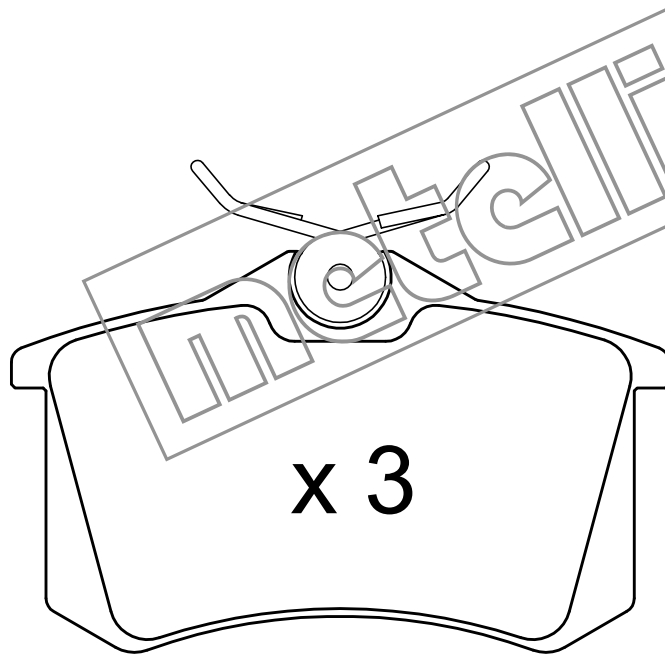
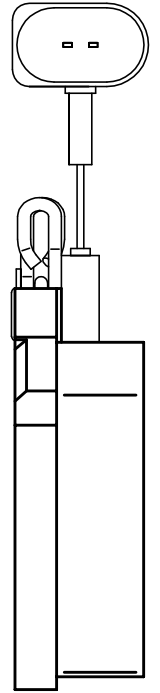

x 3

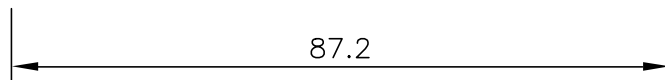

87.2

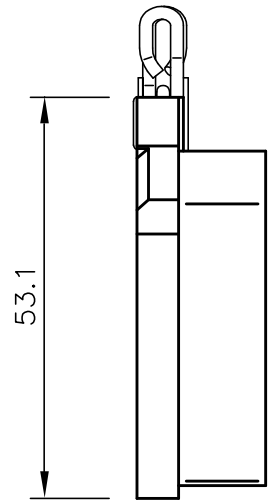

53.1

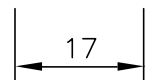

17

metelli